

AGM 33 PIKE™

Specifications

Length: 66.5"

Diameter 4.0"

Weight: 60oz

Recovery: 36" Nylon Chute

Motor Mount: 38mm

Fins: 6 - 1/4" Plywood

CP: 49" from nose tip

Parts List

- (1) Nose Cone
- (1) Pre-slotted main body tube (31")
- (1) Payload section body tube (19")
- (2) Centering rings
- (1) Coupler
- (1) Bulkhead
- (1) Motor tube
- (6) laser-cut fins
- (2) Eyebolt, nut and washer
- (1) Nylon shock cord
- (2) Rail buttons, (2) screws, (1) weld nut
- (1) 12x12 Chute Protector (optional)
- (1) 36" Nylon chute (optional)

You'll need these items to complete this kit

- 5 Minute Epoxy
- Lead Shot for Balance
- Filler and Paint
- Zap or CA Super Glue
- Motor Retainer
- 120/220 Sandpaper
- Pencil



K-169



Please make sure you read all directions and understand how to assemble your model before you start construction. It is also a good idea to test fit each part before assembly – some manufacturing tolerances may require light sanding before final assembly.

Laser cut parts will exhibit varying amounts of charring on the edges depending on the density of the plywood. The charred edges do not interfere with bonding and do not need to be cleaned before assembly. In most cases the charring will be cleaned up during sanding for finishing and painting.

Motor Mount Assembly

- Step 1 - Sand the glassine coating off of the motor tube. Epoxy will not stick very well to the glassine and roughing the tube will help the epoxy stick.
- Step 2 - Test fit the centering rings over the motor mount tube and sand if necessary. The ring should slide snug over the motor tube without deforming it. Also test fit the centering rings in the body tube and sand if necessary.
- Step 3 - One of the rings will have a hole for an eyebolt to attach the shock cord - this will be the forward ring. Spread some epoxy on the outside of one end of the motor tube and slide the forward ring (with the extra hole) until there is approximately 1/2" of motor tube exposed.

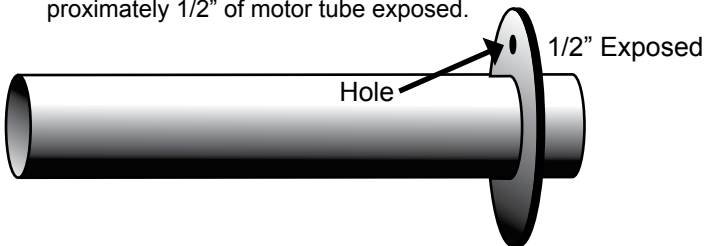

- Step 4 - After the forward ring is dry, spread some epoxy on the other side of the motor tube and slide the aft ring until there is 1/2" exposed on the aft end of the motor tube. **VERY IMPORTANT: make sure there is not any epoxy on the motor tube between the 2 rings that would interfere with the fin tangs later on.**

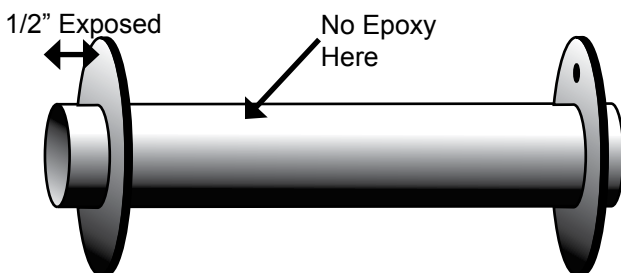

- Step 5 - Mount the eyebolt using the nut and washer in the forward ring hole. Apply some epoxy to the threads of the eyebolt and nut to ensure it will not come loose later. Make sure the eyebolt is aligned so that it will not interfere with the body tube when the motor assembly is inserted into the body tube later.

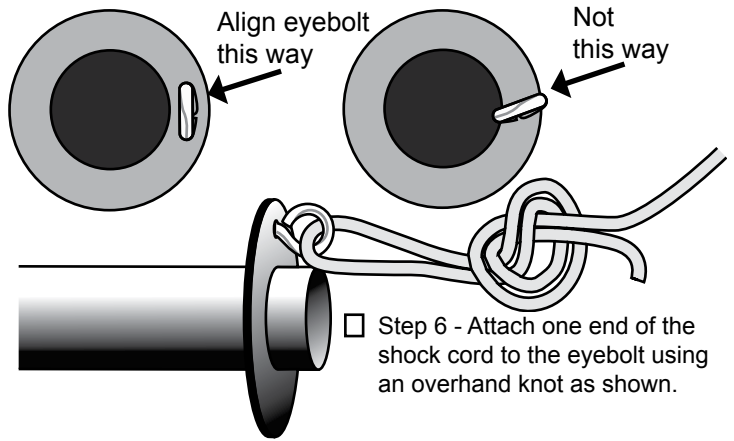
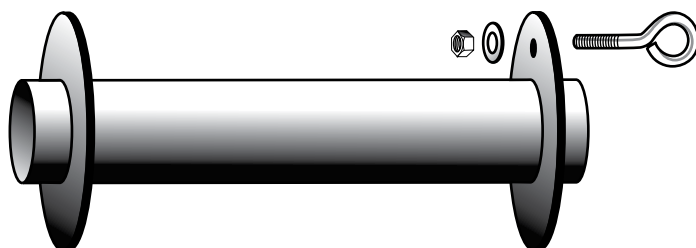

- Step 6 - Attach one end of the shock cord to the eyebolt using an overhand knot as shown.

Body Tube Assembly

- Step 7 - Wrap the shock chord into a small bundle and stuff it inside the motor tube for this next step. Test fit the motor tube assembly into the aft end (end closest to the slots) of the body tube to ensure a snug fit. Sand the centering rings if necessary.
- Step 8 - When you are satisfied with the fit, spread some epoxy on the inside of the body tube about 5" from the aft end and slide the forward centering ring of the motor assembly into the body tube. **Make sure you have the motor assembly facing the right way - the centering ring with the eyebolt should slide in first!**

Keep going by spreading some more epoxy on the inside of the body tube near the aft edge before sliding the aft centering ring into the body tube. Continue sliding the assembly inside the body tube until the aft centering ring is all the way in body tube with the aft end of the motor tube lining up with the aft end of the body tube. It's a good idea to test fit a fin in each slot here before the epoxy sets. Hold the body tube with the motor tube assembly down until the epoxy sets. Make sure the weight of the motor assembly doesn't cause it to slide out of alignment.

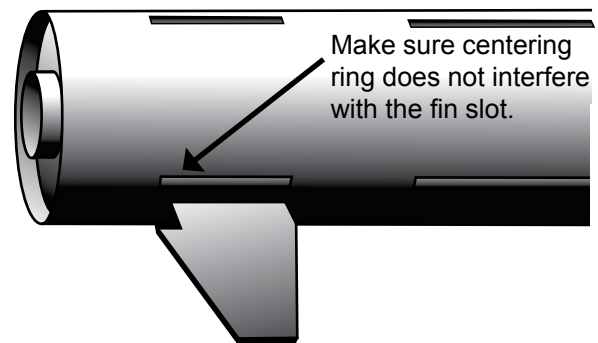

Fin Assembly

- Step 9 - Using a door jam or small section of angle stock, pencil a line halfway between two of the fins that extends from the front to the back of the body tube. This line will be used later to align the rail buttons.

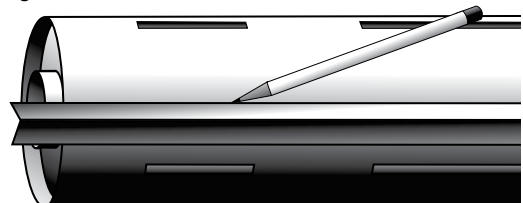

- Step 10 - Test fit each of the fins into the pre cut fin slots. The fin should seat firmly against the motor tube - sand each fin if necessary.

When you are satisfied with the fit, apply some epoxy to the end of the fin tang that will contact the motor tube as well as any fin root that will contact the body tube. Also, spread a thin layer of epoxy on each side of the fin tang. Slide the fin into place and check the alignment. Continue rechecking the fin alignment until you are sure the epoxy has set. Clean any excess epoxy from around the fin joint. Repeat for the remaining fins.

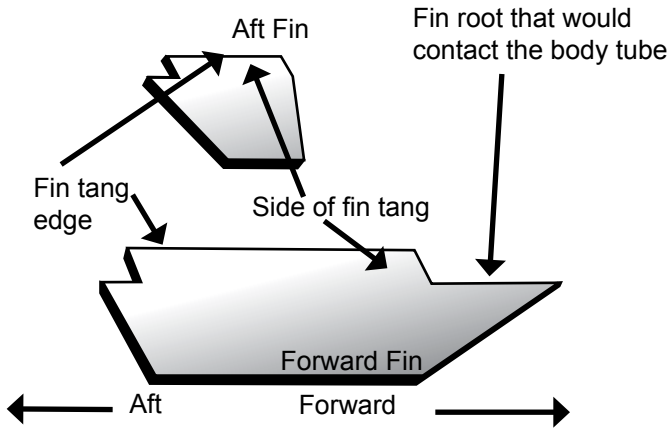

- Step 11 - Next, apply epoxy fillets to both sides of each fin. Carefully smooth the epoxy fillets with your finger before the epoxy sets. Allow each fillet to set before rotating the airframe for the next fillet.

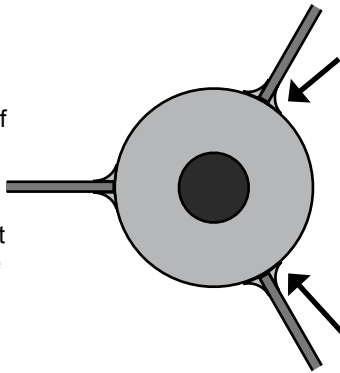

- Step 12 - It is also a good idea to CA the sharp tips of the fins to keep them from splintering on hard landings.

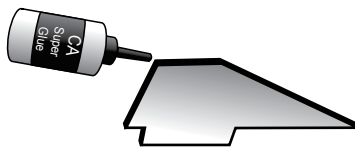

Rail Button Attachment

- Step 13 - Drill a 5/64" hole on the rail button line for the aft rail buttons ensuring the hole goes into the aft centering ring.
- Step 14 - Apply a small amount of epoxy in the hole and attach the rail button using the supplied #6 wood screw. Make sure the screw is loose enough for the rail button to spin freely - this ensures the button is not compressed to the point it will hang on the rail guide.
- Step 15 - Drill a 3/16" hole on the rail button line for the forward rail button. The forward hole should be 6" from the forward end of the main body tube. **IMPORTANT:** Make sure there is at least 6" from the forward end of the body tube or the rail button will interfere with the coupler.

- Step 16 - Insert the weld nut from the inside of the body tube through the previously drilled hole. You can hold the nut in place with a little CA if you like (be careful not to get any of the CA glue inside the threads). Place the rail button over the weld nut and secure with the short 6-32 screw. It is a good idea to use thread lock on the screw threads to keep it from coming loose later.

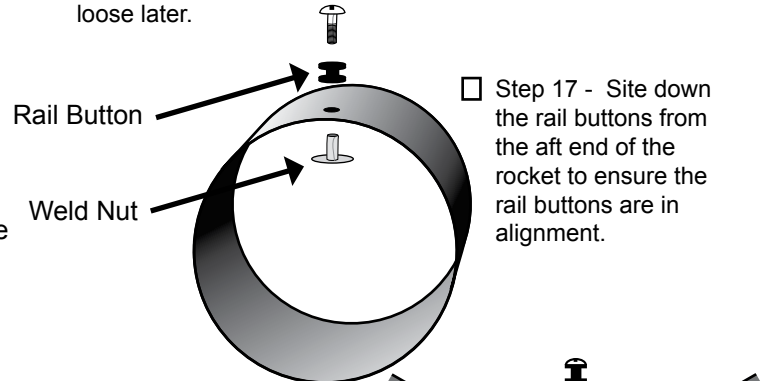

- Step 17 - Site down the rail buttons from the aft end of the rocket to ensure the rail buttons are in alignment.

- Step 18 - Apply some epoxy over the forward weld nut inside the body tube. Build up a smooth epoxy bump over the screw so the recovery system doesn't get hung up on the nut during motor ejection.

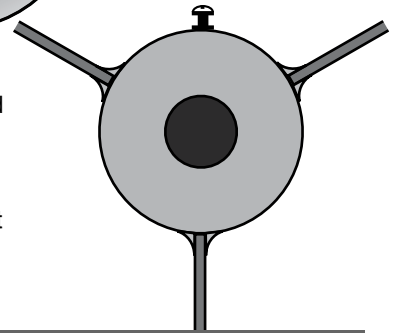

Payload Section Assembly

- Step 19 - Insert the eyebolt through the hole in the center of the bulkhead and secure using the washer and nut. **IMPORTANT: Apply some epoxy to the nut and eyebolt threads to ensure the nut doesn't come loose later.**

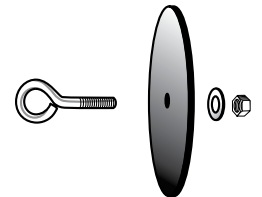

- Step 20 - Apply some epoxy to the inside of the coupler and push the bulkhead in so there is about a 1/8" to 1/4" of coupler exposed. After the epoxy has set, apply a fillet of epoxy around the inside edge of the coupler bulkhead joint.

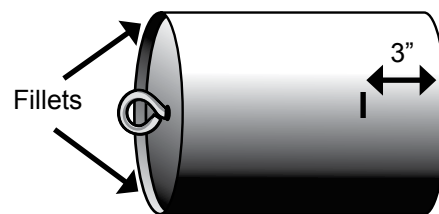

- Step 21 - Next mark the coupler 3" from the forward edge. Apply some epoxy to the inside of the forward body tube section and slide the coupler up to the mark. There should be 5" of coupler exposed. Make sure the coupler is straight and the body tubes are aligned properly when they are assembled later.

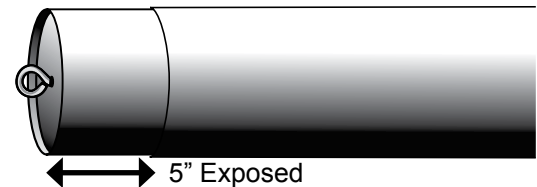

Balancing Your Model

- Step 22 - Pack the chute and assemble the rocket. When packing your chute, wrap the chute protector around the chute with the opening in the chute protector facing forward. Always make sure your chute is well protected as the hot ejection motor gasses will melt the nylon chute.
- Step 23 - Pack the chute and assemble the rocket. Insert the largest motor that you intend to fly (or simulate the weight with an appropriate substitute) and ensure that the CG is at least 1 body diameter in front of the estimated CP point specified on the first page. The estimated CP should be measured from the tip of the nose cone.
- Step 24 - If the CG is behind the specified point, add weight inside the nose cone by pouring lead shot into the nose cone and adding some epoxy. Hold the nose cone with the tip down so the weight will be as far forward as possible.
IMPORTANT: Screw in several screws through the plastic nose cone into the lead to hold it in place. Grind or cut off the screw head before filling and applying the nose cone finish. The epoxy will not stick to the inside of the nose cone and if you do not anchor with screws, the liftoff force will cause the weight to become dislodged causing an unstable model. When you are satisfied with the balance of your model, attach the nose cone to the payload section.

IMPORTANT: Proper CG is critical to the stability of this model. This model will require some ballast in the nose - the amount will depend on how you build and the size motor you use to fly. Do not fly without balancing this model properly as a dangerous unstable flight will result.

Final Assembly

- Step 25 - Using the same knot you used in step 6, attach the other end of the shock cord to the payload section eyebolt.
- Step 26 - Attach the parachute to the shock cord near the payload eyebolt. Also attach the chute protector to the shock cord near the same location.
- Step 27 - Drill a small 1/8" hole in the chute compartment to allow venting. Make sure you do this without the chute in the chute compartment.
- Step 28 - At this point install your positive motor retention device. The kit does not include a motor retention device and this will need to be purchased separately.
- Step 29 - Your model is now ready to paint.

At this point your model is ready to fly.

Now go have some fun!

Flying Your Model

IMPORTANT: always use positive motor retention to secure the motor. Failure to use motor retention will cause the motor to be ejected instead of the parachute making for a dangerous ballistic reentry.

IMPORTANT: always remember to check your balance point and ensure your CG is forward of the specified CG point.

IMPORTANT: Always follow the NAR safety code and remember that rockets are not toys and can be dangerous if not prepared and used properly. If you are a beginner, it is a good idea to fly with a club or other group of experienced rocketeers until you have gained some experience.

IMPORTANT: In no event shall Madcow Rocketry be liable for any direct, indirect, punitive, incidental, special consequential damages whatsoever arising out of or connected with the use or misuse of its products. The buyer assumes all risk and liability resulting from ANY use of any and all products sold by Madcow Rocketry. Your purchase and use of any Madcow Rocketry product constitutes your agreement to and acceptance of these terms. If you do not agree to these terms and conditions, you must return the unused product in resalable condition for a refund or credit.

IMPORTANT: Please contact us via phone or email if you have any questions about constructing or flying your model.



24338 El Toro Rd #E-134

Laguna Woods, CA 92637

949.547.8847

www.madcowrocketry.com

support@madcowrocketry.com

©2011 MadCow Rocketry™