

BalloonSat Easy v 3.2

by NearSys

The BalloonSat Easy is the second in the series soldering and microcontroller programming trainers. When assembled, students have a programmable flight computer for BalloonSats capable of collecting data from up to three sensors, controlling a servo, and operating a camera. Sensor data is stored onboard the BalloonSat Easy's memory chip and downloaded after recovery. It's a programmable combination of data logger and camera timer, but in a small and lightweight package.

**Onwards and Upwards,
Your near space guide**

Overview of the BalloonSat Easy Project

There are 36 parts in this kit that when soldered together, create a programmable BalloonSat flight computer. The heart of the BalloonSat Easy is a PICAXE-18X - an easy to program microcontroller. The PICAXE-18X's internal memory is limited to 2,048 bytes, or about 600 to 1,000 lines of code. However, the PICAXE's BASIC programming language is sufficiently powerful that only a fraction of the memory is required to operate most near space missions.

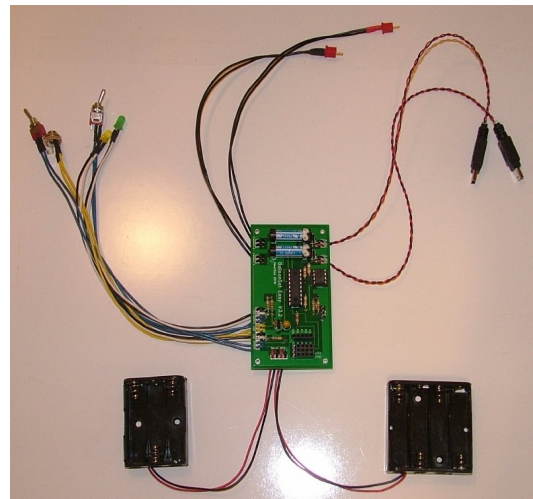

Figure 1. The BalloonSat Easy flight computer

Data collected during the mission is stored in a separate memory chip of the 24LCxx family. Depending on the particular memory chip used, a mission can record over ten thousand readings. Although experimental data is stored on a memory chip, this does not preclude the PICAXE-18X from storing data. A four cell "AAA" battery pack provides power for the flight computer and attached experiments. An attached servo gets power through a separate three cell "AAA" battery pack. There are two camera ports on the BalloonSat Easy and it can support both modified camera shutters and Canon cameras with CHDK installed and running the USB remote. The Easy's I/O port provides power to any attached experiment. The BalloonSat Easy V 3.2 has a second I/O port, the Easy-

Plug I/O Port that makes it simpler to build I/O ports for experiments. The weight of the BalloonSat Easy and its batteries is only 125 grams. That leaves a lot of weight free for the BalloonSat airframe and sensors.

These instructions assume that beginning students will receive some help if they have never soldered before. To program the BalloonSat Easy, students will need access to a PC with the PICAXE program editor installed. The kit also assumes a camera has been prepared for the flight computer. Therefore, the proper connector for the camera cable must be provided to complete the assembly of the BalloonSat Easy.

Parts List

Look at the top of the printed circuit board (PCB) and you'll see white lettering indicating the placement and orientation of individual electronic components. Each component has a unique and meaningful reference consisting of a letter followed by a digit. All resistors for example, have a reference beginning with the letter R. Below is a list of the components in the BalloonSat Easy kit and their references you'll find on the PCB.

C1 47uF tantalum capacitor
D1 1N4001 diode
D2 1N4001 diode
RL1 6V reed relay
RL2 6V reed relay
R1 10k ohm resistor (brown, black, orange, gold)
R2 22k ohm resistor (red, red, orange, gold)
R3 4.7k ohm resistor (yellow, violet, red, gold)
R4 4.7k ohm resistor (yellow, violet, red, gold)
R5 4.7k ohm resistor (yellow, violet, red, gold)
R6 680 ohm resistor (blue, gray, red, gold)
R7 1k ohm resistor (brown, black, orange, gold)
R8 330 ohm resistor (orange, orange, brown, gold)
R9 680 ohm resistor (blue, gray, red, gold)
U1 18-pin socket
U2 8-pin socket
U3 LM2950 +5 volt regulator (TO-92)

The remaining items are required to complete the BalloonSat Easy, but they do not have a reference on the PCB.

Two 3- pin straight header
3 by 4 female receptacle
1 by 5 female receptacle
PICAXE-18X (microcontroller)
24LC128 (I2C memory)
Wire (#24 AWG)
4 "AAA" cell holder

3 “AAA” cell holder
Two toggle switches
Two LEDs
1/8” phono jack
1/8” phono plug
Printed Circuit Board
Heat shrink tubing (two inches long)

Component Pictorials

The following pictures illustrate the physical appearance of the components you’ll find in the kit. The integrated circuit and its socket are for illustration only; these parts in the BalloonSat Easy have eighteen pins.

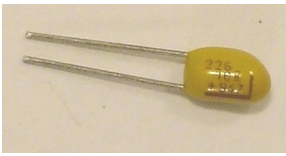

Figure 2. Capacitor

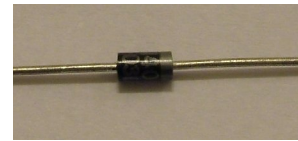

Figure 3. Diode

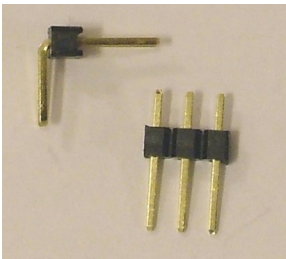

Figure 4. Headers

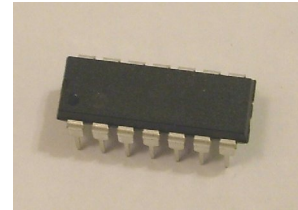

Figure 5. Integrated circuit (IC)

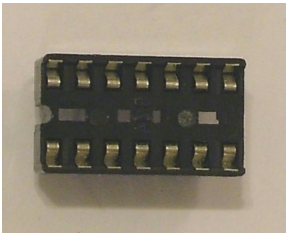

Figure 6. IC Socket

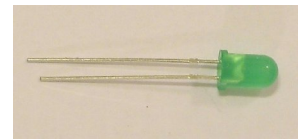

Figure 7. Light-emitting Diode (LED)



Figure 8. Printed circuit board (PCB)

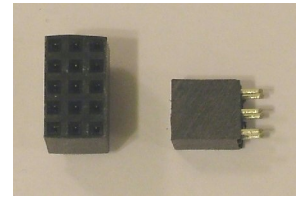

Figure 9. Receptacles

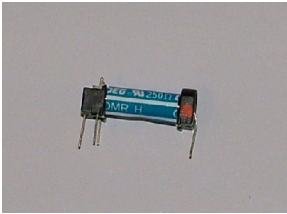

Figure 10. Reed relay



Figure 11. Resistor



Figure 12. Toggle switch

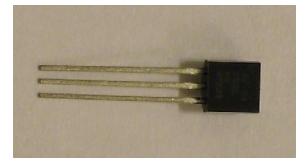

Figure 13. Voltage regulator



Figure 14. Mono jack and case

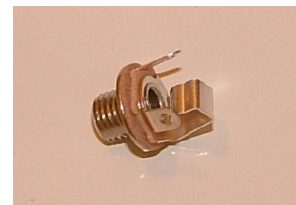

Figure 15. Mono receptacle

Theory of Operation

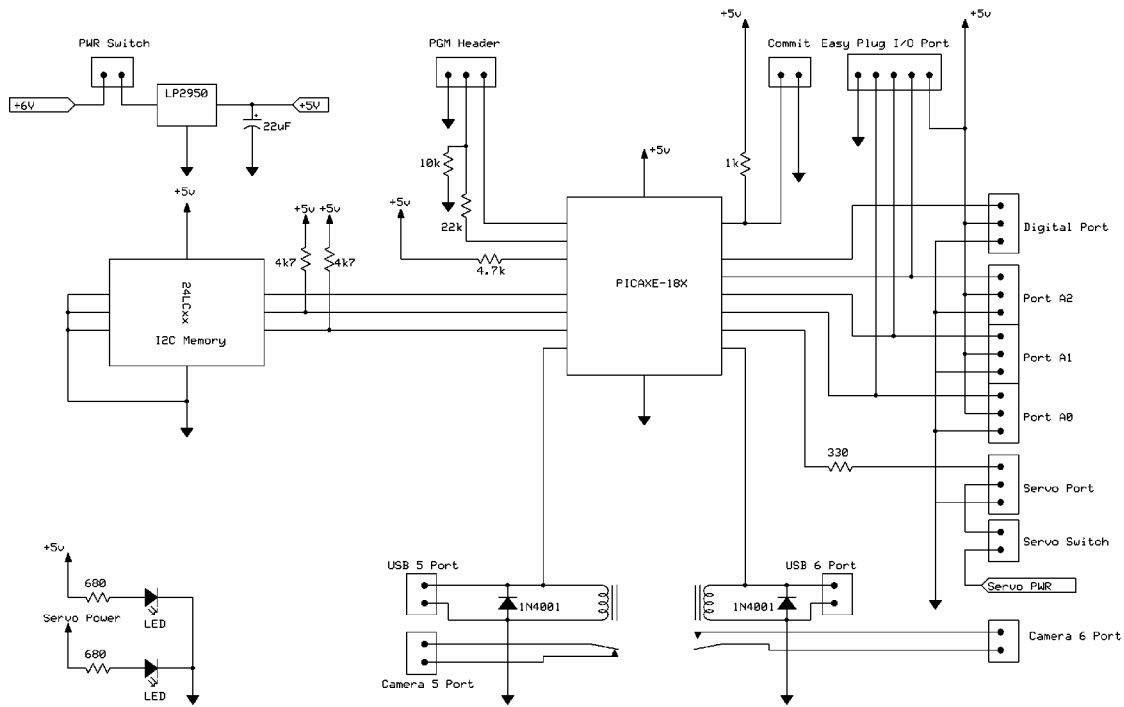

Figure 16. BalloonSat Easy Schematic

The arrangement of components in the BalloonSat Easy are designed to support the PICAXE-18X in the process of collecting and storing data. Below is a brief description of each component and how it supports the mission of the BalloonSat Easy.

The voltage regulator (LM2950) converts the slowly declining voltage of the four “AAA” battery pack into a constant five volts that the PICAXE prefers. The 47 uF capacitor next to the voltage regulator acts as a temporary battery and helps the voltage regulator maintain a more constant five volt output. If the voltage surges slightly higher, the capacitor absorbs the excess current; changing it into charge stored on its plates and bringing the voltage back down. If the voltage drops slightly lower, the capacitor dumps its stored charge; changing it into needed current and pushing the voltage higher. The Main Power toggle switch connects the nine volt transistor battery to the voltage regulator, allowing the control of the power from the outside of the BalloonSat.

The two LEDs light up when main power or servo power switches on. Therefore the LEDs are solely power indicators (there is no other way to see that the BalloonSat Easy is operating). The 680 ohm resistors connected to the LEDs limit current flowing through them so they and the voltage regulator are protected from excessive current.

The program header is a three straight pin header that connects a PC to the PICAXE so the PICAXE Editor can download its program into the BalloonSat Easy. The 22k resistor limits the amount of current flowing between the PC serial port and the PICAXE during the programming process. The 10k resistor is a pull down resistor that ensures then when

no programming instructions are flowing between the PC and PICAXE, the PICAXE won't detect false data.

The Commit Pin is a 1/8 inch phono jack and plug. When the plug is not plugged into the jack, a five volt signal is applied to the PICAXE's input pin 7. The five volt signal, which is created by the 1k pull-up resistor, signals the PICAXE to begin collecting data. The second wire soldered to the 1/8 inch jack connects to ground, or zero volts. While the Commit Pin is inserted into the jack, input pin 7 is shorted to ground, bypassing the pull-up resistor. The PICAXE sees zero volts in place of the original five volts and waits to begin collecting data. Monitoring input pin 7 means the PICAXE can wait for hours before recording data.

The 24LC128 is an I2C EEPROM memory IC that stores up to 16 kilobytes of mission data. The eight pin device can be replaced with memory chips with greater storage space. The 24LC128 receives data from the PICAXE and stores it in nonvolatile memory. In that way, the data is retained even if the battery is removed from the BalloonSat. The two 4,700 ohm resistors between the PICAXE and memory are pull-up resistors. They ensure a +5 volt signal is always present on the communication lines between the PICAXE and memory when no data is being sent between them. The address lines of the 24LC128 are grounded to give the chip an I2C address of 00000000.

The three analog ports onboard the PCB provide each experiment with +5 volts, ground, and a unique connection to the PICAXE. In return, the experiment provides data to the PICAXE for recording. The data from sensors is typically a voltage that varies by magnitude in response to a particular environmental condition. The fourth port is a digital port for monitoring a voltage that either is on or off based on conditions or is data consisting of meaningful pulses. A typical experiment for the digital port is a geiger counter. The program downloaded into the PICAXE analyzes the output from sensors and records the results for downloading after recovery.

Output pin 5 and 6 are connected to the camera relays. Cameras with modified shutter switches connect to these relays and are triggered into taking photographs. The wire coil inside the relay is energized every time the PICAXE is programmed to take a picture. By energizing the coil, a magnetically activated switch inside the relay closes and triggers the camera shutter attached to the BalloonSat Easy. When the relay's coil is de-energized, the collapsing magnetic field of the coil induces a backwards flowing current towards the PICAXE. In a large coil, this current can be great enough to damage the PICAXE. The PICAXE protected from the back current by a diode. By orienting the diode in the proper direction, this back current is safely routed to ground and away from the PICAXE. The relay used in the BalloonSat Easy is pretty small, so probably the diode is not necessary. However, at an altitude of 100,000 feet, it's better to safe than sorry.

In place to using cameras with modified shutters, there are two additional cables for connecting digital Canon running CHDK remote shutter. The USB camera ports do not true USB ports, they only send a +5 volt signal over the USB cable to trigger the Cannon.

The Servo 3 port (the male header at the end of the flight computer's I/O port) is a connection to the PICAXE-18's pulse width modulation (PWM) output. A servo positions itself based on the width of the pulses sent to it. The shortest pulse is normally around 1 millisecond long and the longest is normally 2 milliseconds long. Between each pulse, there is a rest of 10 to 20 milliseconds long. A servo needs at most 20 to 30 pulses to position itself. When too few pulses are sent to the servo, it does not have time to travel to its new position before the pulses stop (without pulses, a servo remains stationary). According to the clock internal to the PICAXE, the extreme positions of a servo are set with a servo commands of 75 to 225. A separate battery pack of three "AAA" cells (or 4.5 volts) operates the servos and is controlled by the Servo Switch. The servo's separate battery pack prevents variations in voltage caused by the servos from interfering with the programming running in the PICAXE. The Servo Port is the three pin male header next to the I/O ports.

Assembly Tools

You'll need the following tools to assemble the BalloonSat Easy (and any other PCB).

Soldering Iron

Use a low wattage, pencil style soldering iron and not a soldering gun. The tip should have a fine point or chisel. A soldering iron with temperature control would be great, but it isn't required to successfully complete the BalloonSat Easy. If you use a soldering iron with temperature control, set the temperature to the mid point.

Sponge

A damp sponge cleans oxide and excess solder from the tip of the soldering iron. Don't poke the sponge with the soldering iron. Instead, quickly wipe the tip of the soldering iron against the edge of the damp sponge. This wipes off the oxide and excess solder leaving the tip clean. After wiping the tip of the soldering iron clean, apply fresh solder to lightly coat the tip in a protective layer of molten solder. The molten solder helps heat flow from the soldering iron to the work.

Solder

Solder is an alloy, or mix of lead and tin. The alloy has a low melting point, but molten solder is still very hot – so be careful when soldering. The narrow channel inside the solder is filled with a flux called rosin. The flux melts first and flows out of the solder to coat the work. Flux helps remove oxide and protects the clean surface so the molten solder that follows the flux will more likely stick to the work. Use a narrow diameter solder, like 0.032 inches to assemble the BalloonSat Easy. Under no circumstances large diameter solder or solder containing an acid flux. The acid flux eventually corrodes electrical connections within the PCB.

Wire Cutters

Wire cutters trim wires to length. The trimming is performed before and after soldering; before to cut wires for the camera cable and after to trim excess lead length. Be aware

that cut leads can fly across the room. So be safe and hold or cover the excess lead so it can't fly away when it is cut.

Wire Strippers

Wire is insulated with a plastic coating; however, wires cannot be soldered through this coating. So it must be removed without damaging the copper wire. Do not use wire cutters to strip wire as they will nick and weaken the wire. There are several different types of wire strippers to safely strip insulation. If your wire strippers have several diameter holes for stripping wire, then use the #24 gauge hole to strip the wires. In a pinch, the wire in the kit can be stripped as #22 gauge. The other type of wire strippers are automatic strippers that adjust to the diameter of the wire as they strip the insulation.

Sandpaper

To keep the cost of the BalloonSat low as possible, several components in the kit are purchased in long strips and cut to their proper size. This includes the receptacles. The cut edges of the receptacle are rough (sorry, I can't shear the receptacles more smoothly), so they'll need to be sanded. Place a sheet of 120 grit sand paper (or other grit close to 120) on top of a flat surface like a table top. Then briskly wipe the raw edge of the receptacle across the surface of the sandpaper. Watch that you don't sand off too much of the receptacle. The cut edge of the receptacle can be made even smoother by switching the 120 grit sandpaper with a 220 and wiping the cut edge across this sandpaper.

Multimeter

While not strictly required, it's a good idea to have access to a multimeter to test and troubleshoot the BalloonSat Easy. The Easy's PCB is design so every flight computer should work upon completion. Nevertheless, on occasion, a bad solder connection can crop up or a component can be damaged. Locating these problems is easier with a multimeter.

Forming and Soldering

The particular order that the components are installed is not really important, however, it is recommended that when soldering, the lowest lying components be installed first.

Before you insert the first lead of a component into a PCB, form the component by bending its leads to the proper length. Then insert the component on the top silk side of the PCB and flush to the PCB (there are a few exceptions that will be noted in the directions). Either bend the leads to hold the component in place or use a little bit of masking tape to hold the component in place while it is soldered. Then flip the PCB over.

A component lead cannot be properly soldered until both the lead and the pad on the PCB are hot. However, if the copper trace or pad on the PCB gets too hot, they will lift and damage the PCB. Therefore, the pad and lead must be heated quickly by using a soldering iron tip that is clean of oxidation and damp with a little solder. Wipe the tip of

the soldering iron on a damp sponge frequently to keep it clean. After cleaning the tip, apply a little solder to it to keep it lightly covered in liquid solder.

Place the tip of the soldering iron to where the component lead and pad meet. Then touch the tip of the solder to the iron and pad/lead to begin melting the solder. Quickly run the solder around the hot pad to create a shallow solder pool over the face of the pad. Then quickly remove the solder followed by the soldering iron.

The solder should form a cone around the pad and up the lead. There should be no major gaps in the solder coverage around the pad or a balling up of the solder. If the soldered connection is nearly good enough then leave it be. Trying to rework a soldered connection invites damage to the PCB.

After the solder cools, cut the excess lead at the top of the solder cone with a pair of wire cutters. Be careful not to cut deeply into the solder cone or else the connection can be damaged.

Assembling the BalloonSat Easy V3.2

The diagram below illustrates the placement of the components you will solder to the BalloonSat Easy PCB. Now you're ready to make a flight computer. Check off each step as you complete it.

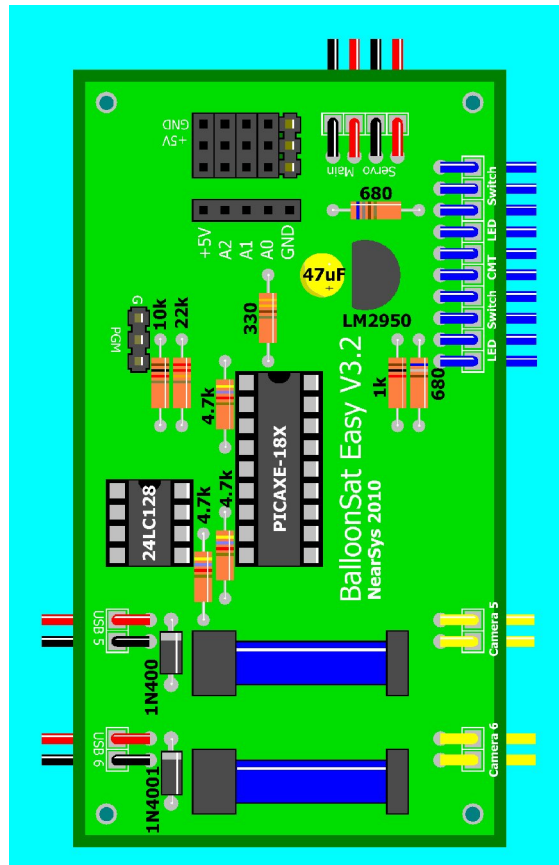

Figure 17. Parts Layout for the BalloonSat Easy V3.2

1. Resistors

Form (bend) the resistor leads before inserting them into the PCB. Each resistor's position is indicated by its R-number.

- R1 10 k-ohms (brown, black, orange, gold)
- R2 22 k-ohms (red, red, orange, gold)
- R3 4.7 k-ohms (yellow, violet, red, gold)
- R4 4.7 k-ohms (yellow, violet, red, gold)
- R5 4.7 k-ohms (yellow, violet, red, gold)
- R6 680 ohm (blue, gray, brown, gold)
- R7 1 k-ohm (brown, black, red, gold)
- R8 330 ohms (orange, orange, brown, gold)
- R9 680 ohm (blue, gray, brown, gold)

2. Diodes

The diode has its name, 1N4001, printed on it and a white stripe painted around one end. Orient the diode's stripe according to the diagram above. If it's backwards, the relay will never trigger the camera and the PICAXE could be damaged.

- D1 1N4001
- D2 1N4001

3. Battery Holders

Solder the 4 “AAA” and 3 “AAA” cell holders to the PCB. The 4 “AAA” cell holder is the BalloonSat Easy's main power and the three “AAA” battery holder provides power for the servo (servos can draw a lot of current, hence a separate battery). Note that there are large diameter holes near the edge of the PCB and smaller holes inside of them. The large holes are the strain relief that will prevent normal usage from breaking the wires off the PCB. The wires of the battery holders are red and black. The red wire is positive voltage and the black is ground. These must be soldered to the proper pads in the PCB or either the flight computer will not power up or the servo won't rotate. Push each wire up through the strain relief hole from the underside of the PCB and then bend each wire down and into its pad. Push the wires through the pads until their insulation is flush with the PCB and no bare wire is exposed above (or nearly no wire is exposed above).

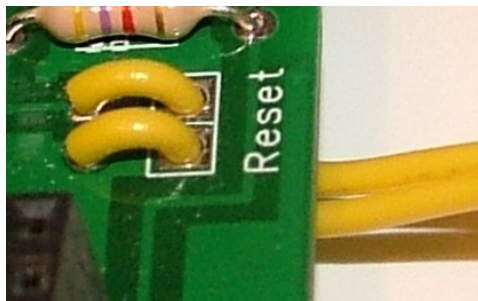

Figure 18. Strain relief for wires soldered to a PCB.

- 4 “AAA” Battery Holder
- 3 “AAA” Battery Holder

4. The Camera, LED Indicator, Commit Pin, and Switch Cables

Solder the wires for the power switches, LEDs, Commit Pin, and cameras. Cut about five inches of wire off the longest wire loop in the kit and set aside. This short wire is the Commit Pin, which will be assembled in step 12. Cut the remaining wire into 10 nearly equal pieces and strip $\frac{1}{4}$ inch of insulation from the ends. Insert each wire into the PCB as you did for the battery holders and solder. Note that you will solder wires to the camera ports later.

Note the pads for these wires are marked in top silk. There are four wires for Main Power (two for the indicator LED and two for the switch), four wires for Servo Power (two for the indicator LED and two for the switch), and two wires for the Commit Pin. The LED wires are polarized. The C is for the cathode of the LED (the lead on the flat side for the LED) and A for the anode (the other and usually longer lead). The switch and commit wires are not polarized.

Slide $\frac{1}{2}$ inch of thinner heat shrink tubing over the ends of the LED, and switch wires. Push the larger diameter heat shrink over the Commit Pin wires. Save the camera wires for later. Push all the heat shrink up to the PCB. This way they won't shrink while soldering the switches to the ends of the wires. Next strip about $\frac{1}{4}$ inch of insulation from the ends of the four switch wires and twist the ends tightly so they won't fray. Now tin the bare wires well.

Tin both leads of both toggle switches. If the switch has three leads, then tin one end lead and the center lead. Lay a tinned switch wire against a tinned switch lead and heat them with a soldering iron until their solder melts and the lead and wire fuse together. Repeat for the remaining lead and wire. Slide the heat shrink to the soldered connection and shrink.

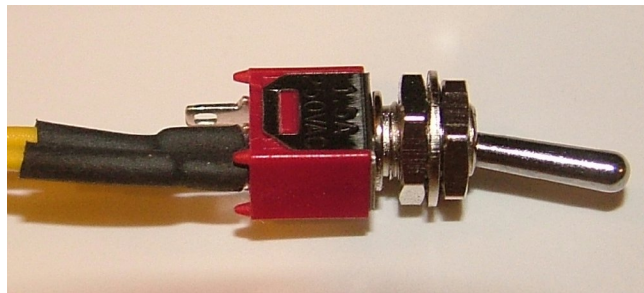

Figure 19. A toggle switch after soldering and heat shrinking.

- Main Power Toggle Switch**
- Servo Power Toggle Switch**

Look on the side of each LED and find the fat edge. See figure 20 for an illustration.

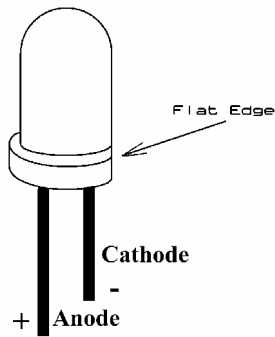

Figure 20. The anode and cathode of a light-emitting diode (LED).

Clip both leads of the LEDs to a length of $\frac{1}{4}$ inch and tin well. Lay the LED wire soldered to the pad marked A along side the anode lead of the LED. Heat both until the solder fuses them together. Repeat for the other LED wire (soldered to the pad marked C) and the cathode lead of the LED. Slide heat shrink over the LED leads and shrink.

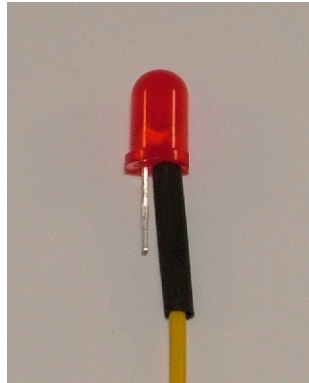

Figure 21. An LED lead soldered and ready for heat shrink.

- **Main Power LED Indicator**
- **Servo Power LED Indicator**

The Commit Jack is a $\frac{1}{8}$ inch phono jack. It has two leads for soldering the Commit Jack wires. This is not a polarized device. Remove at least $\frac{1}{2}$ inch of insulation from the ends of the Commit Jack wires. Pass one of the wires half way through a hole in the solder tabs of the phono jack. Twist the wire around the jack tightly and solder. Repeat for the other Commit Jack wire. Slide the heat shrink up the soldered connection and shrink.

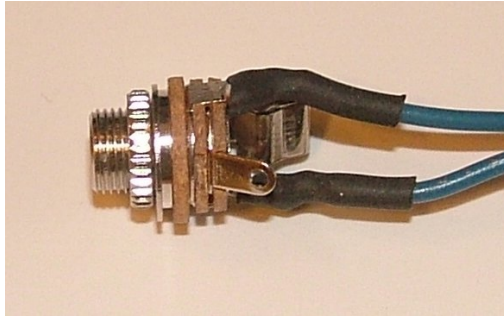

Figure 22. This 1/8 inch jack is a stereo jack and therefore has three solder tabs. Otherwise, this is what you completed phono jack will look like (sans the used third tab) after soldering it to the flight computer.

□ **Commit Jack**

5. IC Sockets

To protect the PICAXE and the memory from heat damage by the soldering iron, solder their IC sockets to the PCB and not the ICs themselves. Electrically speaking, the orientation of the IC sockets doesn't matter. However, still solder the sockets with their notches aligned with the notches on the top silk graphic. The notch in the IC sockets will then specify the proper orientation of the PICAXE and memory when you install them. If the PICAXE or memory is installed backwards, the BalloonSat Easy will not function. Do not install the PICAXE or memory into their sockets before soldering the sockets to the PCB – this defeats the purpose of using the socket. Do not insert the PICAXE or memory yet, as the BalloonSat Easy must be tested first.

□ **U1 18-pin IC socket**

□ **U2 8-pin IC socket**

6. Capacitor

The capacitor is polarized, so look for a plus (+) mark stamped on its body. The plus marks the positive lead. Orient the capacitor according to the diagram above and solder. The capacitor will probably resist being set flush to the PCB, so don't force it.

□ **C1 47 microfarads**

7. Voltage Regulator

The voltage regulator is polarized, so install it with the flat face of the regulator aligned with its top silk illustration. This is another component that will not sit flush on the PCB, so don't force it.

□ **U3 LM2950**

8. Relays

The pattern of pins on the underside of the relay makes very obvious its proper orientation. The relay sits flush to the PCB surface.

□ **RL1 Reed relay**

□ **RL2 Reed relay**

9. Servo Port and Receptacle

The I/O receptacle was cut from a longer block of receptacles, so its edges are raw. Use a utility knife or sand paper to smooth its edges. The receptacle must be trimmed back until it and the servo header can be soldered to the PCB and the servo header stands straight up. You'll need to continually sand (or trim with the utility knife) and test fit. Once the fit together properly, solder.

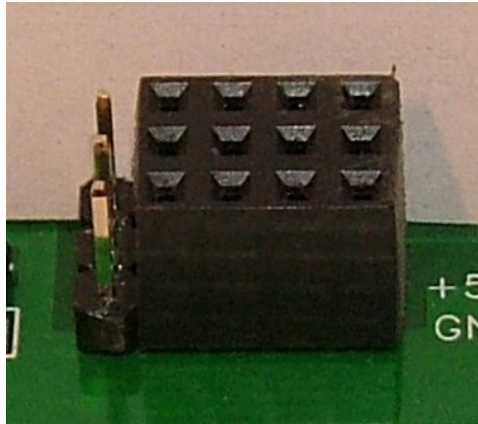

Figure 23. The proper fitting of the servo header and analog/digital port.

- **1 by 3 Header**
- **3 by 4 Receptacle**

10. Easy-Plug Adapter

The Easy-Plug is a 1 by 5 receptacle. The five contacts in the receptacle contains +5 volts, ground, and access to the BalloonSat Easy's analog ports. There is no access to the digital port. The receptacle was cut from a longer strip, so its edges are raw. Smooth them with sand paper or a small file and then solder the receptacle in place. There are polarization issues and the function of each receptacle is marked on the PCB's top silk.

- **5-pin Easy-Plug Receptacle**

11. Program Header

Insert the short ends of the header's pins into the PCB and push it until its plastic base sits flush to the PCB.

- **3-pin Straight Pin Header**

12. Commit Pin

The Commit Pin is a shorted 1/8 inch phono plug. There are two tabs to solder the short piece of wire from step 4. Strip one inch of insulation from one end of the wire, wrap it through and around the large tab of the phono plug and solder. Bare 1/4 inches of the other end of the wire, insert it into the center barrel of the phono plug, and solder. Fold the wire in the middle of its loop.



Figure 24. The phono plug after soldering its shorting wire.

Cut off the narrow tail of the phono plug's plastic jacket and then test fit the jacket. The folded shorting wire protrudes from the narrow back opening of the jacket and the jacket screws onto the plug. Remove the jacket and apply a liberal coating of hot glue around the back end of the plug. Be sure that you don't put glue on the threaded base of the plug. Before the glue has a chance to cool, reassembly the plastic jacket and phono plug. Squirt some hot glue into the back opening of the jacket so it fills the jacket with a solid block of plastic.

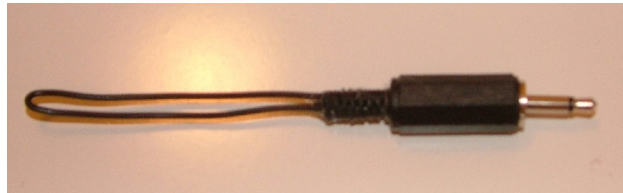

Figure 25. The completed Commit Pin. Note that the narrow tail of this jacket has not removed.

Checking Your Work

That completes the assembly of the BalloonSat Easy. However, don't plug the PICAXE-18X, memory, or battery in just yet. That's because if there is an error in the assembly, the flight computer could be damaged when powered up. Let's first perform five checks to test the quality of the assembly of the BalloonSat Easy.

1. Check the Soldering

Check the underside of the PCB looking for blobs of solder that may bridge across two pads. If there appears to be such a bridge, briefly apply some heat to the pads with your soldering iron and "pull" the molten solder into two separate cones. Or you could lay solder wick across the solder and try to wick up the excess solder. Do these actions quickly as too much heat can damage copper traces on the PCB.

2. Check for Shorts

Set the multimeter to the continuity setting and tap the test leads together. The multimeter will ring or beep to indicate there is a short between the test leads. Now perform the test for real by applying the test leads to the two battery terminal contacts in the nine volt battery snap. There should be no ringing. If there is, then there's a short in the PCB that needs to be located and fixed. Pretty much the only way a short can exist in the PCB is through a solder bridge. So look over the underside of the PCB again, for a solder connection that has overflowed its pad.

3. Check Voltages

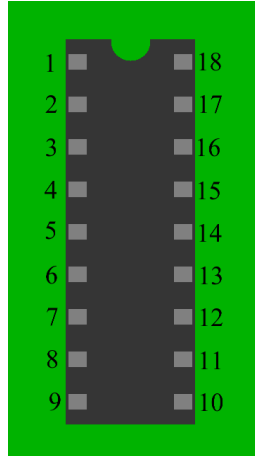

Figure 26. The pin out of the 18 pin IC socket.

Set the multimeter to measure DC voltage. Insert four “AAA” cells into the battery holder and turn on the BalloonSat Easy’s main power. Measure the voltage across pins 5 and 14 of the 18-pin IC socket. With the red lead on pin 14 and the black lead on pin 5, the multimeter will display a voltage between +4.75 and +5.25 volts.

Check the commit header voltage by leaving the black test lead on pin 5 and moving the red test lead to pin 16. The multimeter will display between +4.75 and +5.25 volts. Next insert the Commit Pin in the Commit Jack and repeat the same measurement. The multimeter will now display close to zero volts.

Check the reset voltage by leaving the black test lead on IC pin 5 and moving the red test lead to pin 4. The multimeter will display between +4.75 and +5.25 volts.

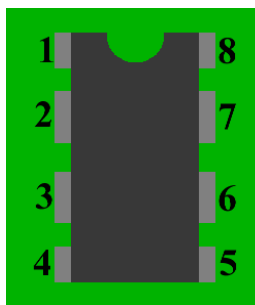

Figure 27. The pin out on the 8-pin IC socket.

Check the voltage on the memory chip socket. Place the red test lead on pin 8 and the black test lead on pin 1. Again, the voltage should read 5.0 volts, plus or minus 0.25 volts. Then place the black test lead on pins 2, 3, and 4 and each time the voltage reading should be the same.

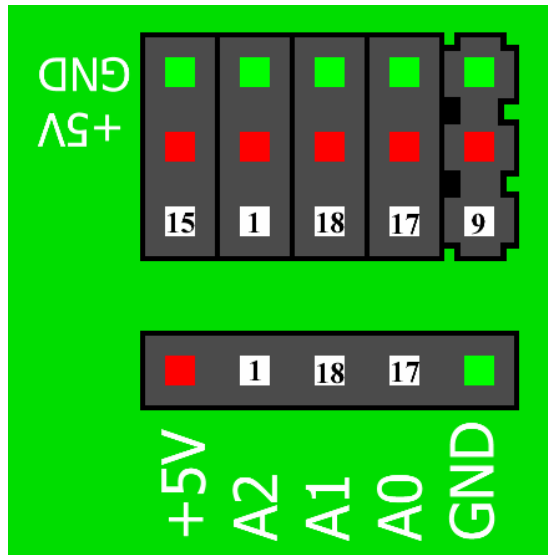

Figure 28. The green squares are the grounds in the I/O port. The red squares are the +5 volts in the I/O port. The white squares are digital and analog connections to the PICAXE-18X.

Check the voltages on the I/O ports. To make an electrical contact with the receptacle, stick cut resistor leads into the openings of the receptacle. The openings marked in red are +5 volts and the ones marked in green are ground, or zero volts. Insert one cut resistor lead into a +5 volt opening and a second resistor lead into a ground opening. Tap the test leads of the multimeter to the resistor leads sticking out of the openings and it should display a voltage between +4.75 and 5.25 volts.

4. Check I/O Continuity

The next test is a continuity test. Disconnect the battery and set the multimeter to measure continuity. The white squares in figure 28 indicate which socket in the 18-pin IC socket each of the sockets in the port connects. Tap one test lead of the multimeter one pin in the IC socket and use a cut resistor lead to make contact with the appropriate opening in the I/O receptacle. The multimeter should ring for each connection.

Servo Header Note

The servo header will test a bit differently than the rest of the I/O ports. Instead of +5 volts, it will read closer to 4.5 volts and the resistance between PICAXE pin 9 and the servo header pin may be too high for continuity. A multimeter set to measure resistance will show a reading of around 330 ohms.

5. Check the PICAXE

With the power off, insert the PICAXE-18X and 24LC128 into their IC sockets and plug a serial programming cable into the programming header on the BalloonSat Easy. Type the following program and download it into the PICAXE by clicking the Download Button. Figure 29 points to the Download button.

DEBUG

If the PICAXE has not been damaged and the programming header is properly soldered, the debug window will open and display a single message. There will be a single debug message and circled in figure 16. The debug window will indicate that the PICAXE's memory bytes (B0 to b13) are set to zero.

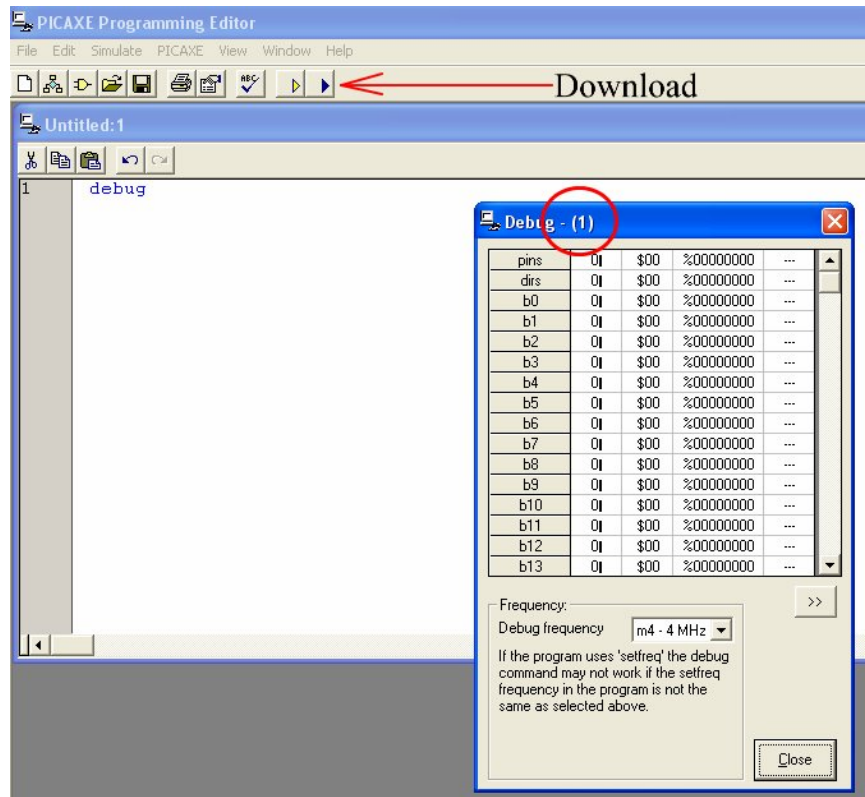

Figure 29. Debug Screen

Protecting the BalloonSat Flight Computer from Short Circuits

Now that the BalloonSat Easy has checked out, it's time to protect the underside from short circuits. As long as the BalloonSat Easy is not placed on top of metal, like wires, the flight computer is safe from accidental short circuits. A short circuit occurs when a piece of metal (a conductor of current) bridges the gap between two solder pads that are not connected by a trace. When current flows between two points that it wasn't designed for, the current can damage the flight computer. To protect the flight computer against short circuits, glue a sheet of ¼ inch thick Foamcore to the bottom of the PCB with hot glue. After the glue cools, seal the open gaps on the edges of the PCB with additional hot glue.

Another method to protect the flight computer from shorts is to mount it to the BalloonSat airframe on a layer of expanded neoprene foam. The foam is available from many hobby stores and sold under names like Fun Foam or Foamies. Use #2-56 bolts or nylon zip ties to mount the flight computer.

Camera Cables

The BalloonSat Easy V3.2 has two pairs of camera ports. The first ports, names Camera 5 and Camera 6 are connected to the two relays. These camera ports are for cameras with modified shutter buttons. The termination for these cables depends on the method used to terminate the camera's shutter cable. A Dean's Micro Plug works well for a standard terminator. Dean's connectors are available at many hobby stores that carry RC cars.

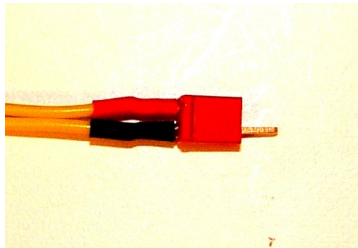

Figure 30. A Dean's Connector attached to a camera cable.

The second pair of camera ports are labeled USB 5 and USB 6. These ports are for Canon cameras running CHDK and the USB remote script. Solder to these ports a stripped down version of the mini USB adapter for the camera. The cable has a mini USB on one end and a regular USB on the other.

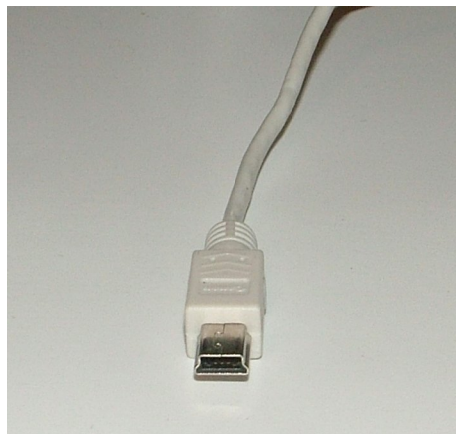

Figure 31. A mini USB for a Canon camera.

The USB remote only uses two wires in the USB cable, +5 volts and ground. The extra wires, shield, and insulation makes the mini USB heavier than necessary. Therefore, cut off the regular USB plug (leave the mini attached) and carefully strip off the outer plastic jacket and inner braid. Be careful not to cut or nick the four thin insulated wires inside the cable. After removing the insulation and shielding, you need to identify the power and ground wires in the USB cable. Several I have used were red for +5 volts and black for ground. However, even if your USB cable has these color wires, it's still a good idea to verify the cable's wires. Use a multimeter to measure continuity and identify the power and ground wires using the small contacts inside the mini USB.

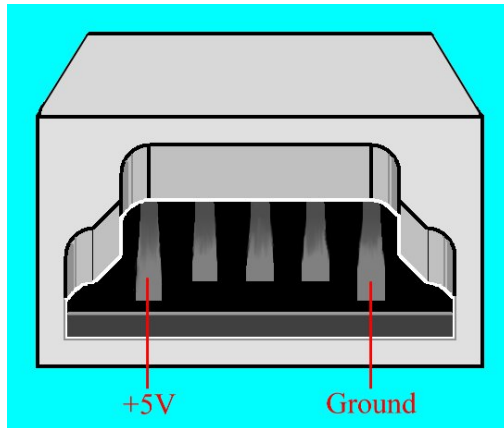

Figure 32. Placement of the +5 volt and ground tabs inside a mini USB.

Once the +5V and ground wires of the cable have been identified, cut off the remaining two wires. Strip $\frac{1}{4}$ inch of insulation from the thin wires and solder them to the USB ports like the other wires (i.e. using the strain relief holes). Whereas polarity isn't an issue with the Camera 5 and 6 ports, it is for the USB 5 and 6 ports. Solder the ground wire to the pad marked with a letter G. All the camera and USB ports can have cables soldered to them. Probably, cameras can be connected to all four cables and operated.

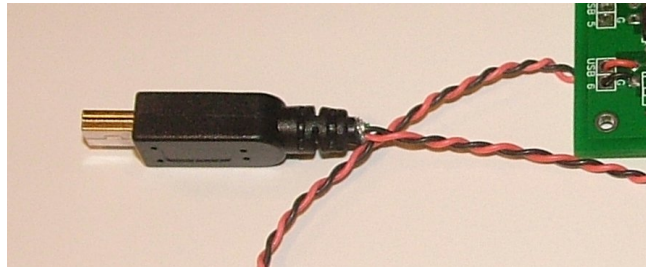

Figure 33. The stripped down mini USB cable soldered to a BalloonSat Easy.

Commit Pin

The Commit Pin prevents the BalloonSat Easy from recording data before the beginning of the mission. There can be times when the BalloonSat will be powered up well before the near spacecraft is launched. As long as the Commit Pin is inserted, the BalloonSat will not begin running experiments and collecting data. This means that someone must pull the Commit Pin shortly before the BalloonSat lifts off. To ensure someone at the launch site will see the Commit Pin, tie a brightly colored ribbon to the pin as shown in figure 34. Use a strong woven cord, like good quality Dacron kite line, to tie a loop in the wire protruding from the back of the Commit Pin. Also tie the cord through a reinforced hole in the brightly colored ribbon.



Figure 34. A brightly colored orange ribbon tied to the Commit Pin. This ribbon ensures that no one forgets to pull the Commit Pin at launch.

Connecting Sensors

NearSys is producing a line of sensor arrays that terminate with the Easy-Plug adapter. The Easy-Plug is a five pin board with +5V, ground, and three sensor voltages.

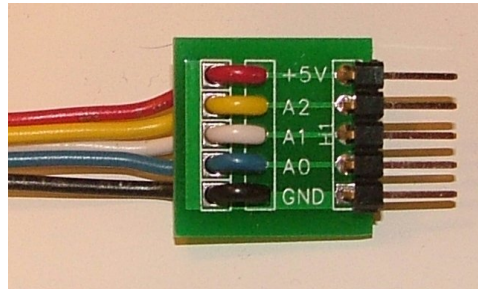

Figure 35. The Easy-Plug adapter for sensor arrays.

The function of each pin is labeled on the adapter board and the Easy-Plug adapter on the BalloonSat Easy. Verify that plug is inserted into the adapter in the correct orientation before applying power. Using the Easy-Plug adapter makes it much easier to terminate the cables of sensor arrays.

Experiments that do not use Easy-Plug must terminate in a three pin header. Each pin has one of the following functions, ground (zero volts or the negative terminal of a battery), +5 volts, and input/output to the PICAXE-18X. The pins of the header have a spacing of 0.1 inch between pins and the pins are 0.025 inches across. A sensor can use a second three pin header and it doesn't have to use all three pins of either header. Typically, a second header is needed when the sensor produces two outputs or it requires a command from the PICAXE to produce an output.

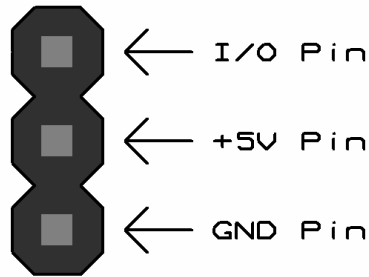

Figure 36. The pin outs of a three pin sensor cable header.

The benefit of using three pin headers is that sensors can be plugged into any I/O channel. As soon as its cable is plugged into a channel, the sensor receives power and communications with the PICAXE. The sensor cable can be moved to a different I/O channel with only a minor change to the flight program. The output from sensors plugged into the BalloonSat Easy can be either an analog voltage, a series of voltage pulses (on and off), or an on-off state.

Making Sensor Cable Terminators

A sensor cable should always be terminated in a three pin header (even if the sensor only needs one or two connections). Headers normally come in a long row designed to be snapped to the proper length. These are referred to as snappable headers. To use them, cut a three pin section off the end of a row of snappable headers. Select one of the end pins to be pin number one. Pin 1 is the signal pin and can be either the output from or input to the sensor. The second pin is the power pin, five volts to operate the sensor comes from this pin. Pin number three is the ground or zero volt pin and completes the circuit for the sensor. Follow these steps to terminate the sensor cable.

1. Tin the short sides of the pins in the header
2. Strip $\frac{1}{4}$ inch of insulation from the wires of the sensor
3. Twist the wires tightly and tin them
4. Cut $\frac{1}{2}$ inch of heat shrink for each wire and slide them over the ends of the tinned wires

Note: Slide the heat shrink away from the tinned ends of the wire or else they may shrink in place when you solder the wires to the header.

5. Place the sensor's signal pin against pin #1 of the header and touch a hot soldering iron to the pin and wire (the solder in the tinned wire and header pin will fuse the two together)
6. Hold the wire against the header pin until the solder cools
7. Repeat for the remaining two pins (+5 volts and ground)
8. Slide the heat shrink over the soldered connections and shrink

Use double row snappable headers to terminate sensor cables requiring a second row of three pin header.

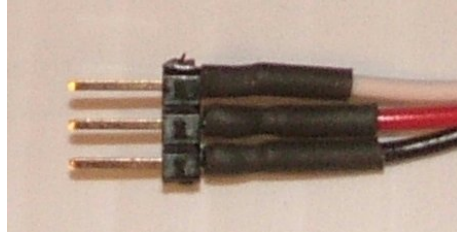

Figure 37. A completed three pin sensor cable. In this example, the black wire is ground, the red wire is +5 volts, and the white wire is the sensor signal. Using color coding like this is the smartest way to make cables.

Examples of Code

This section contains examples of the commands used most often in a BalloonSat Easy flight program. This is not meant as a replacement for the PICAXE BASIC Commands Guide.

FOR

This command instructs the PICAXE to begin a loop of program. The program loop is typically a sequence of commands that collects sensor values and stores them into memory. By using a program loop, the program only needs to be written once since it can be repeated ad infinitum.

IF PIN3 =

This command instructs the PICAXE to check the voltage on the Commit Header (the input pin 3 of the PICAXE-18X). If the value of this pin is 1 (five volts) then the Commit Pin has been removed.

NEXT

This command instructs the PICAXE that this is the end of the program loop. The sequence of commands between the FOR and NEXT statement will be repeated during the mission until an event specified in the FOR statement is met.

READ

This command instructs the PICAXE to read a value, usually a sensor value, out of memory so it can be displayed on a PC.

READADC

This command instructs the PICAXE to digitize the voltage on a particular input pin. The voltage is digitized to an eight-bit level. This means the voltage, from 0 to 5 volts, is divided into 8-bits, or 256 units. Five volts divided by 256 units implies that each unit or count is equal to 0.0195 volts.

READADC10

This command instructs the PICAXE to digitize the voltage on a particular input pin. The voltage is digitized to a ten-bit level. This means the voltage, from 0 to 5 volts, is

divided into 10-bits, or 1024 units. Five volts divided by 1024 units implies that each unit or count is equal to 0.0049 volts.

READI2C

This command instructs the PICAXE to read two bytes of data from the memory IC using the I2C communication method. Normally the retrieved data is then displayed on the PC.

SERVO

This command instructs a pin to create a square wave. The length of time the square wave is high determines the final position of the servo. As long as the square wave pulses are sent, the servo will continue to maintain its instructed position. When the pin stops sending pulses, the servo can easily be rotated to a new position.

SYMBOL

This statement instructs the PICAXE to use a specific meaningful name for a specific byte or word in RAM. The PICAXE has a proper name for every byte and word in RAM like B1 or W2, which are not very useful. The SYMBOL statement creates a new name for bytes and words that the average human being will understand.

WRITE

This command instructs the PICAXE to store a number, usually a sensor value, into memory. After the recovery of the BalloonSat Easy flight computer, the READ command retrieves the stored value.

WRITEI2C

This command instructs the 24LCxx memory IC to store two bytes of data in a specific location in memory using the I2C communications method. After the recovery of the BalloonSat Easy flight computer, the READI2C command retrieves the stored value.

I2C Notes

IIC (or I2C) is a form of synchronized serial communications that relies on two independent pins for signals. One is the clock, which sends square waves to coordinate the communications between the slave and master ICs. Communications takes place over the second pin.

The 24LC128 memory chip included in the BalloonSat Easy requires the following command be included in to the flight program.

i2cslave %10100000,i2cfast,i2cword

The command instructs the PICAXE on the proper way to communicate with the 24LC128 memory IC.

The amount of data that can be stored inside the memory IC depends on the particular version of the IC plugged into the socket. The table below is a list of the valid ICs and their internal memory.

24LC32A	4 kb
24LC65	8 kb
24LC128	16 kb
24LC256	32 kb
24LC512	64 kb

The memory IC used in the BalloonSat Easy expects data to be stored in one word, or two byte, records. Therefore, if the READADC command is being used to collect sensor data, then two sensors should be flown on the mission or memory space will be wasted. Alternatively, the BalloonSat Easy can carry a single sensor as long as the READADC10 command is used. This is because the READADC command only returns a single 8-bit (or one byte) record for each reading. The READADC10 returns a reading 10-bits wide which is too large for a single byte. The benefit is that the sensor data contains more details.

Example Flight Program

You'll find example flight programs for the BalloonSat Easy on the NearSys website (nearsys.com) under the NearSys Catalog.

PICAXE Links

You'll find PICAXE resources like the program editor and datasheets at the PICAXE website: <http://www.rev-ed.co.uk/picaxe/>

The Program Editor's Help menu contains the BASIC command references for the PICAXE.

1 Oct 2010